



atom'air

AMBIENCE IN MOTION

Exhaust Fans and Bathroom Heaters



evolt

QUALITY, RELIABILITY, VALUE

atom'air

Ambience in motion

Bring a peaceful ambience to bathrooms, laundries, and ensembles with the Atom Air range of **exhaust fans** and **bathroom heaters**.

These **stylish** powerhouses deliver **efficient** extraction, making sure it's hot air and not energy bills going through the roof.







Warranty

Buy with confidence, knowing you are covered by Atom's comprehensive warranty.

We provide a leading **3-year** replacement warranty on the entire range of Atom Air **exhaust fans**.

For homeowners, bathroom heaters have a **3-year in-home warranty** to cover an electrician in the event of a product fault.



Exhaust fans

Exhaust fans are integral in bathrooms and ensuites for removing moisture and odours, maintaining a pleasant environment.

Powered by **energy-efficient** motors, Atom Air exhausts are designed for **fast installation**, most of them with a convenient flex and plug.

Choosing an exhaust fan	8
Eclipse	10
Azzure	14
Gust	16
Aero.....	20
Ventura.....	22
Proton.....	26
Airboost.....	28
Wallflo	32

Choosing an exhaust fan

Without proper ventilation, moisture and mould can build up, leading to extra cleaning, maintenance, and potential long-term health problems. Unchecked, this can cause structural damage to the property.

Size matters

Choosing a fan with sufficient airflow is crucial to handle the steam in your bathroom. Calculate the room's volume (height x width x length) and consider the number of air changes per hour required.

We recommend 10 air changes per hour for an ensuite or laundry, and 15 for a full bathroom with a shower.

We have done the hard work for you, please refer to the Area suitability (m²) figures on page 64.



Adequate ventilation

For the exhaust fan to function effectively, an equal volume of replacement air must be able to enter the room; the fan will not function efficiently in an airtight room.

This is generally via an open window, vent or gap under the door. Choose an exhaust fan that has a draught stopper and ensure that the ducting is properly sealed to prevent air from leaking back into the bathroom.

Location, location, location

For best results in removing moisture, the exhaust fan should be positioned as close as possible to the source of the moisture and away from any source of replacement air. Placing the exhaust away from doors or windows creates cross-ventilation, ensuring that it can effectively service the entire room.

For best results, we do not recommend placing exhaust fans and bathroom heaters directly above shower recesses. Please refer to AS/NZS 3000 for further information when locating exhausts or bathroom heaters close to, or above showers and other wet zones.



Ducting

Building regulations require exhaust fans to be ducted outside, not into a ceiling or wall cavity. Keep ducting runs short and straight for optimal performance, and consider the use of an inline exhaust fan for sufficient performance in long runs.

Other factors to consider

There are several factors that might suggest you require a more powerful exhaust fan.

- High ceilings require more powerful fans due to the larger air volume and distance from the moisture source.
- Open showers disperse more steam, needing a stronger fan.
- High humidity levels can increase the amount of moisture in the air and slow down air movement, further hindering the efficiency of the exhaust fan.



3YR

Return to base warranty



Easy install



Quiet operation
<45dB

ECLIPSE

Keep air fresh and healthy with the Eclipse ducted exhaust fan. Supplied with flex and plug for easy installation, the Eclipse has an easy to clean matte white fascia, with square and black options also available.

Product features

- Powerful ball bearing motor for superior reliability
- Draught stopper for improved energy efficiency
- Enjoy quiet operation
- Supplied with 0.9m flex and plug for easy installation
- 3-year return to base warranty for peace of mind

Accessories

16776 ECLIPSE/TRIM/240/B/RD fascia	12677 AT9492 125mm duct adapter
16777 ECLIPSE/TRIM/290/B/RD fascia	14851 TIMER/RO 1-25min run-on timer
16778 ECLIPSE/TRIM/240/WH/SQ fascia	14852 DUCT/100/6M 100mm x 6m duct
16779 ECLIPSE/TRIM/290/WH/SQ fascia	14853 DUCT/150/6M 150mm x 6m duct
16780 ECLIPSE/TRIM/240/B/SQ fascia	13538 VENT/100/EXT/WH/SQ 100 mm vent
16781 ECLIPSE/TRIM/290/B/SQ fascia	13536 VENT/150/EXT/WH/SQ 150 mm vent

Product range

Code	Description
ECLIPSE/240/WH/RD SKU: 16757	240mm 30W ducted exhaust fan with round white fascia
ECLIPSE/290/WH/RD SKU: 16758	290mm 35W ducted exhaust fan with round white fascia
ECLIPSE/240/WH/SQ SKU: 16784	240mm 30W ducted exhaust fan with square white fascia
ECLIPSE/290/WH/SQ SKU: 16785	290mm 35W ducted exhaust fan with square white fascia

Product specification

Voltage	220-240V~50Hz	
IP Rating	IPX4	
Fan type	Centrifugal fan	
Connection	Flex & plug	
Flex & plug length	900mm	
Warranty	3 years	
	ECLIPSE/240	ECLIPSE/290
Exhaust	30W ball bearing motor	35W ball bearing motor
Noise level	42dB	45dB
Outlet	100mm	150mm
Air Extraction	270m ³ /hr	350m ³ /hr
Cutout	Ø240mm	Ø290mm
Min. ceiling depth	220mm	220mm

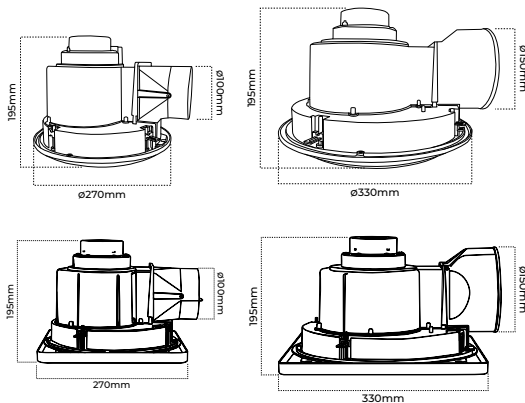



Return to base warranty



Quiet operation
<45dB



TRI-CCT luminaire

ECLIPSE/LT

Keep air fresh and healthy with the Eclipse ducted exhaust fan with LED light. Supplied with flex and plug for easy installation, the Eclipse also has square fascia options available.

Product features

- Powerful ball bearing motor for superior reliability
- Tri-CCT LED panel provides energy-efficient illumination
- Enjoy quiet operation
- Supplied with separate 0.9m flex and plug leads for fan and light for easy installation
- 3-year return to base warranty for peace of mind

Accessories

16782 ECLIPSE/TRIM/240/LT/WH/SQ fascia

16783 ECLIPSE/TRIM/290/LT/WH/SQ fascia

14851 TIMER/RO 1-25min run-on timer

12677 AT9492 125mm duct adapter

14852 DUCT/100/6M 100mm x 6m duct

14853 DUCT/150/6M 150mm x 6m duct

13538 VENT/100/EXT/WH/SQ 100 mm vent

13536 VENT/150/EXT/WH/SQ 150 mm vent

Product range

Code	Description
ECLIPSE/240/LT/WH/RD SKU: 16759	240mm 30W ducted exhaust fan with round white fascia and LED panel - Tri-CCT
ECLIPSE/290/LT/WH/RD SKU: 16760	290mm 35W ducted exhaust fan with round white fascia and LED panel - Tri-CCT

Product specification

Voltage	220-240V~50Hz
Light colour options	Tri-Colour 
Colour temperature	3000K, 4000K, 5000K
IP Rating	IPX4
Fan type	Centrifugal fan
Connection	2x Flex & plug
Flex & plug length	900mm
Warranty	3 years

	ECLIPSE/240/WH/RD	ECLIPSE/290/WH/RD
Exhaust	30W ball bearing motor	35W ball bearing motor
Light	12W LED panel	18W LED panel
Lumen output	900lm, 1000lm, 900lm	1300lm, 1500lm, 1300lm
Noise level	42dB	45dB
Outlet	100mm	150mm
Air Extraction	270m ³ /hr	350m ³ /hr
Cutout	Ø240mm	Ø290mm
Min. ceiling depth	220mm	220mm

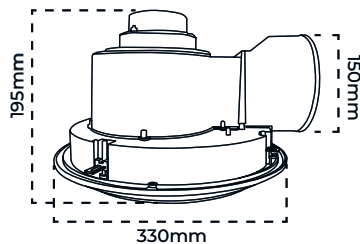
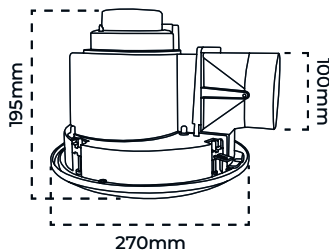



Return to base warranty



Ball bearing motor



Quiet operation
<42dB

AZZURE

Keep air fresh and healthy with the Azzure ducted exhaust fan. The Azzure features an easy-to-clean matte white fascia, with square and black options available. This model is hardwired and includes a run-on timer to meet NCC requirements.

Product features

- Built in run-on timer to meet NCC requirements
- Powerful ball bearing motor for superior reliability
- Draught stopper for improved energy efficiency
- Enjoy quiet operation
- 3-year return to base warranty for peace of mind
- Needs a constant power supply (permanent active)

Accessories

- 16776** ECLIPSE/TRIM/240/B/RD fascia
- 16778** ECLIPSE/TRIM/240/WH/SQ fascia
- 16780** ECLIPSE/TRIM/240/B/SQ fascia

- 12677** AT9492 125mm duct adapter
- 14852** DUCT/100/6M 100mm x 6m duct
- 13538** VENT/100/EXT/WH/SQ 100 mm vent

Product range

Code	Description
AZZURE/240/WH/RD SKU:14843	240mm 30W ducted exhaust fan with round white fascia and run-on timer

Product specification

Voltage	220-240V~50Hz
IP Rating	IPX4
Timer range	1-25m
Fan type	Centrifugal fan
Connection	Terminal block
Exhaust	30W ball bearing motor
Noise level	42dB
Outlet	100mm
Air Extraction	270m ³ /hr
Cutout	Ø240mm
Min. ceiling depth	220mm
Warranty	3 years

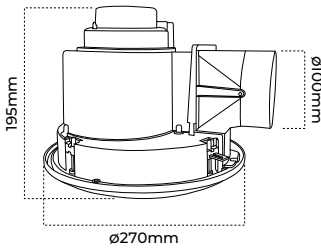

NOTE: This product requires a constant power supply (permanent active).



Return to base warranty



Airflow
High velocity



Quiet operation
<45dB

GUST

Providing impressive extraction with a modern design, the Gust ducted high velocity exhaust fan is perfect for larger bathrooms. Behind the easy to clean fascia, a powerful ball bearing motor maintains airflow over longer ducting runs.

Product features

- High velocity airflow
- Enjoy quiet operation
- Draught stopper for improved energy efficiency
- Supplied with 0.9m flex and plug for easy installation
- 3-year return to base warranty for peace of mind

Accessories

14851 TIMER/RO 1-25min run-on timer

14854 DUCT/125/6M 125mm x 6m duct

14853 DUCT/150/6M 150mm x 6m duct

13535 VENT/125/EXT/WH/SQ 125 mm vent

13536 VENT/150/EXT/WH/SQ 150 mm vent

Product range

Code	Description
GUST/240/WH/RD SKU: 15558	240mm 35W ducted exhaust fan with round white fascia
GUST/295/WH/RD SKU: 16763	295mm 65W ducted exhaust fan with round white fascia

Product specification

Voltage	220-240V~50Hz	
IP Rating	IPX4	
Fan type	Centrifugal fan	
Connection	Flex & plug	
Flex & plug length	900mm	
Warranty	3 years	
	GUST/240	GUST/295
Exhaust	35W ball bearing motor	65W ball bearing motor
Noise level	41dB	45dB
Outlet	125mm	150mm
Air Extraction	330m ³ /hr	640m ³ /hr
Cutout	Ø240mm	Ø295mm
Min. ceiling depth	200mm	240mm

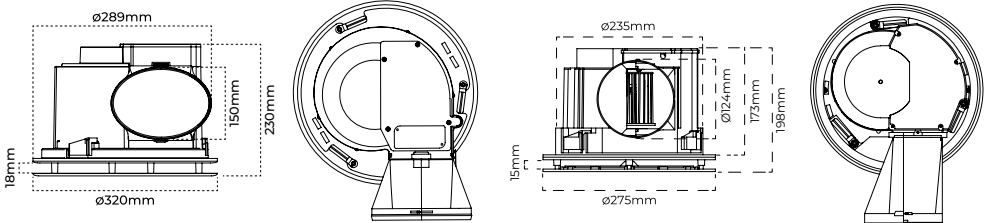



**Return
to base**
warranty



Airflow
High velocity



TRI-CCT
luminaire

GUST/LT

Providing impressive extraction with a modern design, the Gust ducted high-velocity exhaust fan is perfect for larger bathrooms. Featuring a powerful 65W ball bearing motor, it maintains airflow over longer ducting runs and includes an integrated LED light for bright illumination.

Product features

- Tri-CCT LED light
- Enjoy quiet operation at just 45dB
- Draught stopper for improved energy efficiency
- Supplied with dual flex and plug leads for easy installation
- 3-year return to base warranty for peace of mind

Accessories

14851 TIMER/RO 1-25min run-on timer

14853 DUCT/150/6M 150mm x 6m duct

13536 VENT/150/EXT/WH/SQ 150 mm vent

Product range

Code	Description
GUST/295/LT/WH/RD SKU: 16764	295mm 65W ducted exhaust fan with round white fascia and LED panel - Tri-Colour

Product specification

Voltage	220-240V~50Hz
Light colour options	Tri-Colour 
Colour temperature	3000K, 4000K, 5000K
Lumen output	1600lm, 1700lm, 1650lm
IP Rating	IPX4
Fan type	Centrifugal fan
Connection	2x Flex & plug
Flex & plug length	900mm
Exhaust	65W ball bearing motor
Light	18W LED panel
Noise level	45dB
Outlet	150mm
Air Extraction	640m ³ /hr
Cutout	Ø295mm
Min. ceiling depth	240mm
Warranty	3 years

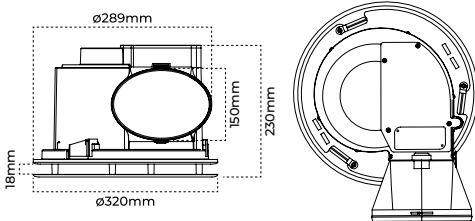



Return to base warranty



3 Speed DC Motor



Airflow
High velocity

AERO

With an efficient 3-speed DC motor and two available sizes, the Aero offers tailored extraction up to 560m³/hr. Remote operation and a ten minute boost mode make the Aero a convenient bathroom companion.

Product features

- 3-speed DC motor for energy-efficient airflow control
- Wireless remote with wall cradle and batteries included
- 24/7 mode for continuous low-speed air circulation
- Boost mode for quick steam extraction (10 minutes)

Accessories

- 14852 DUCT/100/6M 100mm x 6m duct
- 14853 DUCT/150/6M 150mm x 6m duct
- 13538 VENT/100/EXT/WH/SQ 100 mm vent
- 13536 VENT/150/EXT/WH/SQ 150 mm vent

Product range

Code	Description
AERO/240/WH/RD SKU: 14844	240mm 30W Ducted DC exhaust fan with round white fascia and 3-speed remote control
AERO/290/WH/RD SKU: 14845	290mm 40W Ducted DC exhaust fan with round white fascia and 3-speed remote control

Product specification

Voltage	220-240V~50Hz	
IP Rating	IPX4	
Fan type	Centrifugal fan	
Connection	Flex & plug	
Flex & plug length	600mm	
Warranty	3 years	
	AERO/240/WH	AERO/290/WH
Exhaust	30W ball bearing motor	40W ball bearing motor
Noise level	58dB	53dB
Outlet	100mm	150mm
Air Extraction	370m ³ /hr	560m ³ /hr
Cutout	Ø240mm	Ø290mm
Min. ceiling depth	185mm	220mm

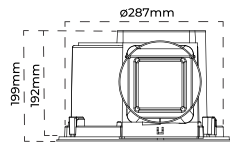
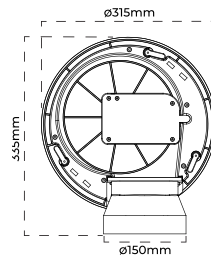
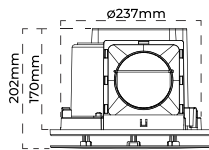
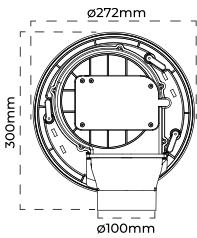

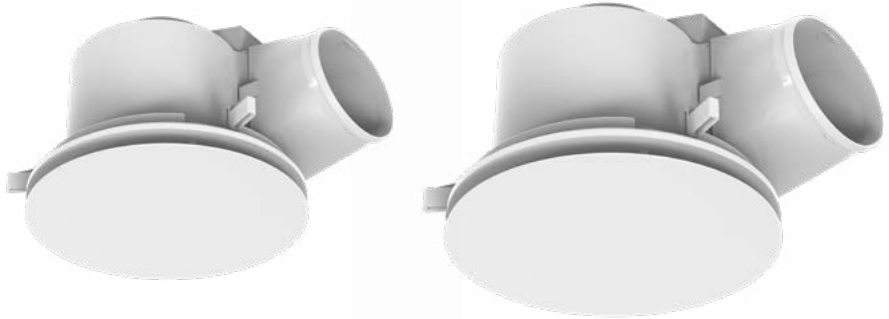

Return to base warranty



DC Motor
Energy saving



Airflow
High velocity

VENTURA

The Ventura high-velocity DC exhaust fan offers energy efficient, quiet clearing of bathroom air. It comes in two sizes and is easy to install with a flex and plug lead.

Product features

- DC motor for high airflow with low power use
- Low noise design for a peaceful bathroom
- High airflow performance to clear steam and odours
- 3-year return to base warranty for peace of mind

Accessories

- 14854** DUCT/125/6M 125mm x 6m duct
- 14853** DUCT/150/6M 150mm x 6m duct
- 13535** VENT/125/EXT/WH/SQ 125 mm vent
- 13536** VENT/150/EXT/WH/SQ 150 mm vent

Product range

Code	Description
VENTURA/240/WH/RD SKU: 13524	240mm 20W Ducted high velocity DC exhaust fan w/round white fascia
VENTURA/295/WH/RD SKU: 13526	295mm 25W Ducted high velocity DC exhaust fan w/round white fascia

Product specification

Voltage	220-240V~50Hz	
IP Rating	IPX4	
Fan type	Centrifugal fan	
Connection	Flex & plug	
Flex & plug length	900mm	
Warranty	3 years	
	VENTURA/240/WH	VENTURA/295/WH
Exhaust	20W ball bearing motor	25W ball bearing motor
Noise level	42dB	37dB
Outlet	125mm	150mm
Air Extraction	420m ³ /hr	550m ³ /hr
Cutout	Ø240mm	Ø295mm
Min. ceiling depth	250mm	250mm

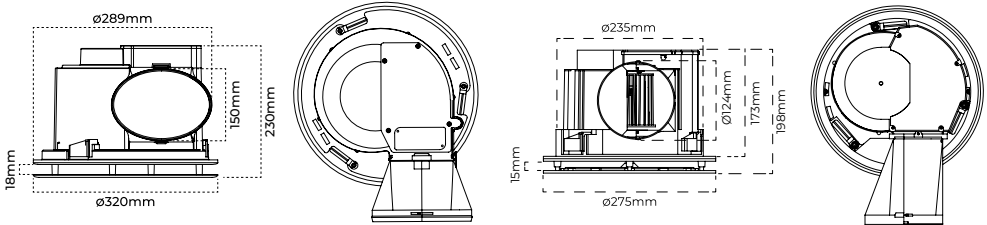

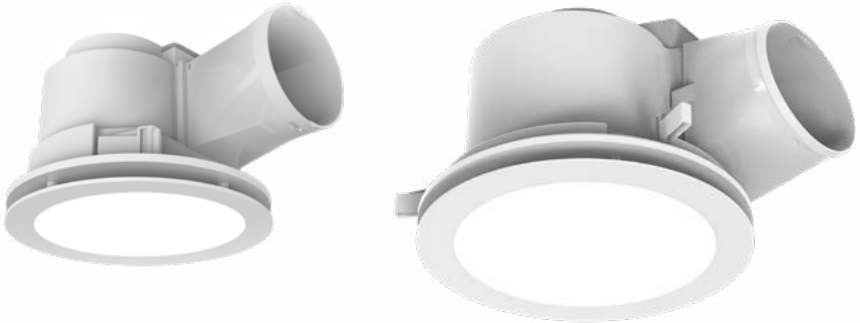

Return to base warranty



DC Motor
Energy saving



Airflow
High velocity

VENTURA/LT

The Ventura high-velocity DC exhaust fan with light offers energy efficient, quiet clearing of bathroom air. It comes in two sizes and features a Tri-CCT LED panel.

Product features

- DC motor for high airflow with low power use
- Low noise design for a peaceful bathroom
- High airflow performance to clear steam and odours
- 3-year return to base warranty for peace of mind

Accessories

14854 DUCT/125/6M 125mm x 6m duct

14853 DUCT/150/6M 150mm x 6m duct

13535 VENT/125/EXT/WH/SQ 125 mm vent

13536 VENT/150/EXT/WH/SQ 150 mm vent

Product range

Code	Description
VENTURA/240/LT/WH/RD SKU:13525	240mm 20W Ducted high velocity DC exhaust fan with round white fascia w/Light - Tri-CCT
VENTURA/295/LT/WH/RD SKU:13527	295mm 25W Ducted high velocity DC exhaust fan with round white fascia w/Light - Tri-CCT

Product specification

Voltage	220-240V~50Hz
Light colour options	Tri-Colour 
Colour temperature	3000K, 4000K, 5000K
IP Rating	IPX4
Fan type	Centrifugal fan
Connection	2x Flex & plug
Flex & plug length	900mm
Warranty	3 years

	VENTURA/240/WH	VENTURA/295/WH
Exhaust	20W ball bearing motor	25W ball bearing motor
Light	12W LED panel	12W LED panel
Lumen output	1600lm, 1700lm, 1650lm	1600lm, 1700lm, 1650lm
Noise level	42dB	37dB
Outlet	125mm	150mm
Air Extraction	420m ³ /hr	550m ³ /hr
Cutout	Ø240mm	Ø295mm
Min. ceiling depth	250mm	250mm

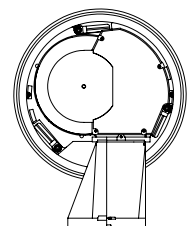
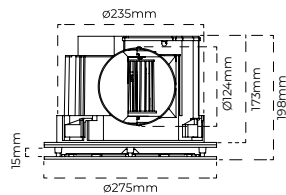
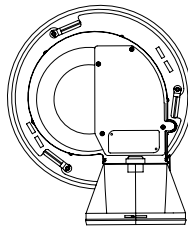
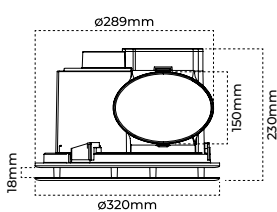



Return to base warranty



Airflow
High velocity



Quiet operation
<36dB

PROTON

The Proton high velocity exhaust fan is a powerful and energy-efficient solution for small-medium bathrooms and ensuites. It features a super-quiet axial fan that provides high air extraction.

Product features

- Powerful motor providing high velocity extraction
- Includes draught stopper for improved energy efficiency
- Supplied with 0.9m flex and plug for easy installation
- 3-year return to base warranty for peace of mind

Accessories

14851 TIMER/RO 1-25min run-on timer

Product range

Code	Description
PROTON/200/WH SKU: 16765	200mm 25W high velocity exhaust fan
PROTON/250/WH SKU: 16766	250mm 32W high velocity exhaust fan

Product specification

Voltage	220-240V~50Hz	
Fan type	Axial fan	
Connection	Flex & plug	
Flex & plug length	900mm	
Warranty	3 years	
	PROTON/200/WH	PROTON/250/WH
Exhaust	25W ball bearing motor	32W ball bearing motor
Noise level	34dB	36dB
Air Extraction	500m ³ /hr	750m ³ /hr
Cutout	Ø240mm	Ø295mm
Min. ceiling depth	215mm	260mm

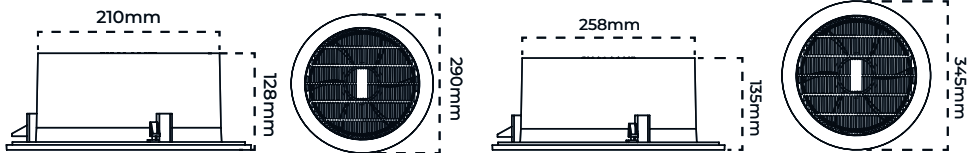



3YR
Return to base
warranty



Airflow
High velocity



Ball bearing
motor

AIRBOOST

The Airboost inline exhaust fan moves air efficiently through longer ducting runs than a typical ceiling exhaust. It's perfect for bathrooms, kitchens, and laundries, and to transfer air between rooms for heating and cooling.

Product features

- High-velocity inline exhaust fan
- Powerful ball bearing motor for superior reliability
- Supplied with 1m flex and plug for easy installation
- 3-year return to base warranty for peace of mind

Accessories

14853 DUCT/150/6M 150mm x 6m duct

13536 VENT/150/EXT/WH/SQ 150 mm vent

Product range

Code	Description
AIRBOOST/150 SKU: 14846	55W 150mm High-velocity inline exhaust fan - w/F&P
AIRBOOST/200 SKU: 14847	135W 200mm High-velocity inline exhaust fan - w/F&P

Product specification

Voltage	220-240V~50Hz	
IP Rating	IPX2	
Fan type	Centrifugal	
Connection	Flex & plug	
Flex & plug length	1000mm	
Warranty	3 years	
	AIRBOOST/150	AIRBOOST/200
Exhaust	55W ball bearing motor	135W ball bearing motor
Noise level	63dB	68dB
Outlet	150mm	200mm
Air Extraction	450m ³ /hr	870m ³ /hr

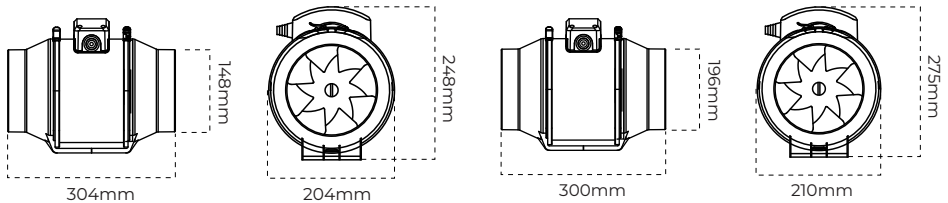



3YR
Return to base
warranty



Airflow
High velocity



Ball bearing
motor

INLINE KIT

The Airboost Inline Kit includes a 150mm Airboost and everything you need for a complete inline exhaust setup.

Product features

- 150mm Airboost inline exhaust fan kit with ceiling vents, external wall grille and ducting
- Single speed wall switch
- Includes 2 x 150mm round ceiling outlets and 150mm exterior wall grille
- Includes 6m of 150mm aluminium ducting and clamps

Accessories

14853 DUCT/150/6M 150mm x 6m duct

13536 VENT/150/EXT/WH/SQ 150 mm vent

Product range

Code	Description
AIRBOOST/KIT/150 SKU:14848	150mm High-velocity inline ducting air transfer kit W/F&P

Product specification

Voltage	220-240V~50Hz
IP Rating	IPX2
Fan type	Centrifugal fan
Connection	Flex & plug
Flex & plug length	1000mm
Exhaust	55W ball bearing motor
Noise level	63dB
Outlet	150mm
Air Extraction	450m ³ /hr
Cutout	Ø240mm
Warranty	3 years

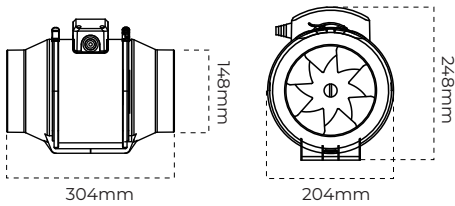



Return to base warranty



IPX4 rated



Quiet operation
<41dB

WALLFLO

The Wallflo is a wall-mounted exhaust fan that's perfect for installs without ceiling access. It delivers a direct, high-efficiency path to clear humid air and includes draught-stopping spring-loaded louvres.

Product features

- Wall-mounted exhaust fan for laundries, kitchens, and sanitary compartments
- Oil bearing motor for superior reliability vertically mounted
- Supplied with flex and plug for easy installation
- 3-year return to base warranty for peace of mind

Accessories

14851 TIMER/RO 1-25min run-on timer

Product range

Code	Description
WALLFLO/150 SKU:14849	150mm Wall exhaust fan - White

Product specification

Voltage	220-240V~50Hz
IP Rating	IPX4
Fan type	Axial flow fan
Connection	Flex & plug
Flex & plug length	1200mm
Exhaust	17W oil bearing motor
Noise level	41dB
Outlet	153mm
Air Extraction	130m ³ /hr
Cutout	Ø150mm
Warranty	3 years

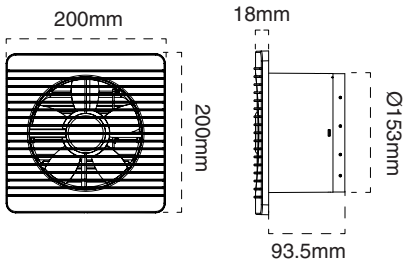



Bathroom heaters

Turn bathrooms into inviting sanctuaries with our range of bathroom heaters. Perfect for creating a **warm haven** on cold mornings, they provide year-round **ventilation** to prevent odours and condensation, along with **energy-efficient** illumination – all in a **stylish**, modern package.

Understanding your bathroom heating options.....	36
Thredbo.....	38
Buller.....	40
Nimbus.....	42
Alta.....	44
Santorini.....	46
Zurich.....	48
St Moritz.....	50
Infraglow.....	54
Heatspot.....	56

Understanding your bathroom heating options

Nobody wants to freeze their bum off getting out of the shower!

Ceiling-mounted bathroom heaters fix that fast and the two main technologies you will find today are infrared (IR) and Positive Temperature Coefficient (PTC). Both do the job, but they work in very different ways. Whether you're installing in a new build or replacing an older unit, understanding the differences can help you choose the right option for your customer.

Infrared (IR)

Infrared (IR) bathroom heaters provide **instant, targeted warmth** by radiating heat directly onto people and surfaces, similar to the feeling of sunlight. This makes them ideal for quick-use spaces like ensuites, where immediate comfort is needed. However, because the heat is directional, it doesn't evenly warm the entire room.



Objects and skin are heated by infrared light

Positive Temperature Coefficient (PTC)

PTC (Positive Temperature Coefficient) heaters, on the other hand, use a fan to circulate warm air and gradually raise the **overall room temperature**. They deliver more consistent, whole-room comfort and feature self-regulating elements that enhance safety and efficiency. While they take slightly longer to heat up, they offer a comfortable, modern solution suited to everyday use and larger bathrooms.



Warm air is circulated throughout the room



In Home
warranty



Instant
Infrared heat



Ball bearing
motor

THREDBO

A 3-in-1 bathroom heater, exhaust fan and LED light, the Thredbo is a convenient solution for smaller bathrooms and ensuites, providing instant heat, high velocity airflow, and bright, efficient lighting.

Product features

- 45W ball bearing motor for superior reliability
- Built-in 80°C thermal cutout switch for added safety
- Outlet grill with integrated draught stopper for maximum efficiency
- 3-year in-home warranty for peace of mind

Accessories

15372 AT9707/ES/TRI R63 8W LED LAMP

15373 AT9708/ES/TRI R80 10W LED LAMP

18716 AT9709/ES/HEAT/275 lamp

14851 TIMER/RO 1-25min run-on timer

14852 DUCT/100/6M 100mm x 6m duct

13538 VENT/100/EXT/WH/SQ 100 mm vent

Product range

Code	Description
THREDBO/2LT/WH SKU: 16767	2 light 3-in-1 bathroom heater and exhaust - Cool white
THREDBO/4LT/WH SKU: 16768	4 light 3-in-1 bathroom heater and exhaust - Cool white

Product specification

Voltage	220-240V~50Hz	
Light colour options	Cool white	
Colour temperature	4000K	
Fan	Centrifugal fan	
Connection	Terminal block	
Exhaust	45W ball bearing motor	
Noise level	45dB	
Air Extraction	280m ³ /hr	
Outlet	100mm	
Warranty	3 years	
	THREDBO/2LT/WH	THREDBO/4LT/WH
Light	8W R63 E27 lamp	12W R80 E27 lamp
Lumen output	850lm	1250lm
Heat	2x 275W IR heat lamps	4x 275W IR heat lamps
Cutout	345x202mm	295x295mm
Min. ceiling depth	220mm	220mm

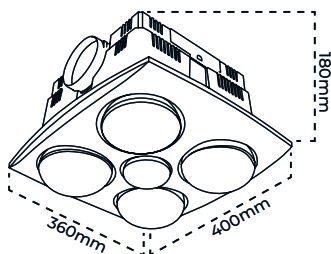
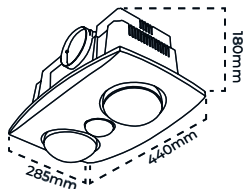



In Home
warranty



Quiet
operation
42dB



TRI-CCT
luminaire

BULLER SERIES II

The Buller provides heating, ventilation and illumination in an energy-efficient design. With instant infrared heating, efficient extraction and illumination, the Buller is ideal for medium-sized bathrooms and ensuites.

Product features

- 35W ball bearing motor for superior reliability
- Quality integrated Tri-CCT LED downlight provides efficient illumination
- Infrared heat lamps provide instant heat
- Built-in 80°C thermal cutout switch for added safety
- 3-year in-home warranty for peace of mind

Accessories

- 18716** AT9709/ES/HEAT/275 lamp
- 14851** TIMER/RO 1-25min run-on timer
- 14854** DUCT/125/6M 125mm x 6m duct
- 13535** VENT/125/EXT/WH/SQ 125 mm vent

Product range

Code	Description
BULLER/2LT/WH SKU: 12695	2-Light 3in1 bathroom heater & exhaust w/LED downlight - white - Tri-cct - Series II
BULLER/4LT/WH SKU: 12696	4-Light 3in1 bathroom heater & exhaust w/LED downlight - white - Tri-cct - Series II

Product specification

Voltage	220-240V~50Hz	
Light colour options	Tri-Colour 	
Colour temperature	3000K, 4000K, 5000K	
Lumen output	880lm, 1000lm, 900lm	
Connection	Terminal block	
Fan	Centrifugal fan	
Exhaust	35W ball bearing motor	
Noise level	42dB	
Air Extraction	305m ³ /hr	
Outlet	125mm	
Light	10W LED downlight	
Warranty	3 years	
	BULLER/2LT/WH	BULLER/4LT/WH
Heat	2x 275W IR heat lamps	4x 275W IR heat lamps
Cutout	375x202mm	320x320mm
Min. ceiling depth	250mm	250mm

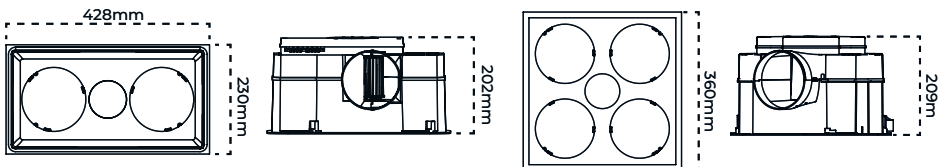



3YR 
In Home
 warranty

Quiet
operation
 42dB

TRI 
TRI-CCT
 luminaire

NIMBUS

The Nimbus is a value-packed 3-in-1 bathroom heater. It features a slim, modern fascia, quiet operation, and two or four bulbs to tailor the heat.

Product features

- 3-in-1 heater, light and exhaust fan combo
- Quiet operation for a more peaceful bathroom
- Two or four 275W heat lamps for instant warmth
- Built-in 80°C thermal cutout switch for added safety
- 3-year in-home warranty for peace of mind

Accessories

18716 AT9709/ES/HEAT/275 lamp

14851 TIMER/RO 1-25min run-on timer

14854 DUCT/125/6M 125mm x 6m duct

13535 VENT/125/EXT/WH/SQ 125 mm vent

Product range

Code	Description
NIMBUS/2LT/WH SKU: 13520	2-Light 3in1 bathroom heater & exhaust w/led downlight - white - Tri-CCT
NIMBUS/4LT/WH SKU: 13521	4-Light 3in1 bathroom heater & exhaust w/led downlight - white - Tri-CCT

Product specification

Voltage	220-240V~50Hz	
Light colour options	Tri-Colour 	
Colour temperature	3000K, 4000K, 5000K	
Lumen output	880lm, 1000lm, 900lm	
Connection	Terminal block	
Fan	Centrifugal fan	
Exhaust	35W ball bearing motor	
Noise level	42dB	
Air Extraction	305m ³ /hr	
Outlet	125mm	
Light	10W LED downlight	
Warranty	3 years	
	NIMBUS/2LT/WH	NIMBUS/4LT/WH
Heat	2x 275W IR heat lamps	4x 275W IR heat lamps
Cutout	375x202mm	320x320mm
Min. ceiling depth	250mm	250mm

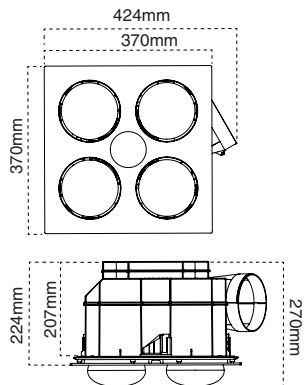
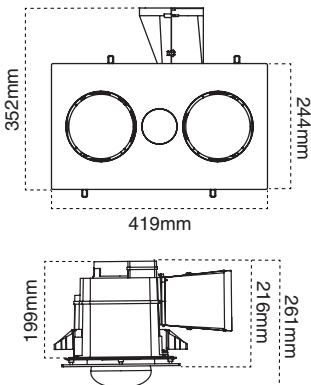



In Home
warranty



Airflow
400m³/hr



TRI-CCT
luminaire

ALTA

Experience optimal comfort with the Alta 3-in-1 unit, combining heating, ventilation, and LED lighting. Perfect for small to medium bathrooms, it features a sleek matte white finish and ensures a cosy, fresh bathroom environment.

Product features

- 40W ball bearing motor for superior reliability
- Tri-CCT colour selectable LED panel provides efficient illumination
- Infrared heat lamps provide instant heat
- IPX2 rated - safe for use in damp environments.
- 3-year in-home warranty for peace of mind

Accessories

- 18716** AT9709/ES/HEAT/275 lamp
- 14851** TIMER/RO 1-25min run-on timer
- 14854** DUCT/125/6M 125mm x 6m duct
- 13535** VENT/125/EXT/WH/SQ 125 mm vent

Product range

Code	Description
ALTA/2LT/WH SKU:14841	2 light high velocity bathroom heater and exhaust with LED panel - Tri-CCT

Product specification

Voltage	220-240V~50Hz
Light colour options	Tri-Colour 
Colour temperature	3000K, 4000K, 5000K
Lumen output	810lm, 900lm, 880lm
Connection	Terminal block
Fan	Centrifugal fan
Exhaust	40W ball bearing motor
Noise level	47dB
Air Extraction	400m ³ /hr
Outlet	125mm
Light	10W
Heat	2x 275W IR heat lamps
Cutout	435x255mm
Min. ceiling depth	220mm
Warranty	3 years

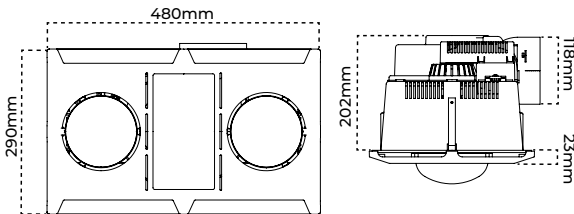



In Home
warranty



PTC
Heater



TRI-CCT
luminaire

SANTORINI

Transform your bathroom to a destination with the Santorini. Featuring an ultra-slim design, PTC heating, powerful ventilation, and bright LED lighting. Ideal for medium to large bathrooms, the Santorini combines functionality and style with year-round comfort.

Product features

- Premium 20W Tri-CCT colour selectable LED panel provides high lumen output
- PTC heater with two setting control (2000W combined)
- Powerful 35W blower fan efficiently warms the entire room
- 535 m³/hr 45W exhaust fan effectively controls steam and moisture
- 3-year in-home warranty for peace of mind

Accessories

14851 TIMER/RO 1-25min run-on timer

14854 DUCT/125/6M 125mm x 6m duct

13535 VENT/125/EXT/WH/SQ 125 mm vent

Product range

Code	Description
SANTORINI/WH SKU: 14834	2000W PTC high velocity bathroom heater & exhaust with LED panel - White
SANTORINI/B SKU: 14835	2000W PTC high velocity bathroom heater & exhaust with LED panel - Black

Product specification

Voltage	220-240V~50Hz
Light colour options	Tri-Colour 
Colour temperature	3000K, 4000K, 5000K
Lumen output	1300lm, 1450lm, 1350lm
Connection	Terminal block
Fan	35W centrifugal fan
Exhaust	45W ball bearing motor
Noise level	52dB
IP Rating	IPX2
Air Extraction	535m ³ /hr
Outlet	125mm
Light	20W LED panel
Heat	2000W PTC heater
Cutout	580x310mm
Min. ceiling depth	220mm
Warranty	3 years

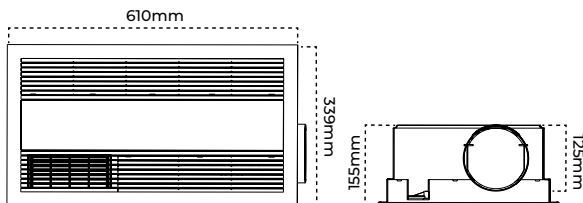



In Home
warranty



PTC
Heater



TRI-CCT
luminaire

ZURICH

The Zurich is perfect for small to medium bathrooms, offering PTC heating, powerful extraction, and bright LED lighting. Its efficient design ensures a comfortable and inviting environment with whisper-quiet operation and easy installation.

Product features

- 35W ball bearing motor for superior reliability
- 20W Tri-CCT LED provides adjustable lighting
- PTC heater with two setting control 1000W & 1000W (combined 2000W)
- Electrician-friendly mount system simplifies setup
- IPX2 rated - safe for use in damp environments

Accessories

10361 AT9491 1000W RJ7S IR Heat Tube

14851 TIMER/RO 1-25min run-on timer

14852 DUCT/100/6M 100mm x 6m duct

13538 VENT/100/EXT/WH/SQ 100 mm vent

Product range

Code	Description
ZURICH/WH SKU: 14836	2000W PTC bathroom heater & exhaust with LED panel - White

Product specification

Voltage	220-240V~50Hz
Light colour options	Tri-Colour 
Colour temperature	3000K, 4000K, 5000K
Lumen output	1200lm, 1300lm, 1200lm
Connection	Terminal block
Fan	35W centrifugal fan
Exhaust	35W ball bearing motor
Noise level	<38dB
IP Rating	IPX2
Air Extraction	310m ³ /hr
Outlet	100mm
Light	20W LED panel
Heat	2000W PTC heater
Cutout	310x610mm
Min. ceiling depth	200mm
Warranty	3 years

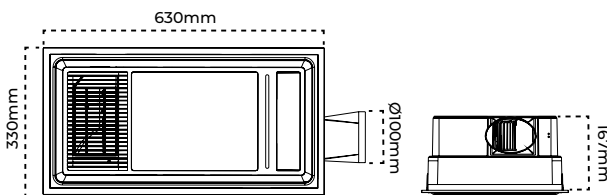



In Home
warranty



Infrared
heat tube



TRI-CCT
luminaire

ST MORITZ

The St Moritz 3-in-1 bathroom heater, exhaust fan, and LED light is a premium solution for larger bathrooms and ensuites. It features a sleek and low-profile fascia, instant infrared heating capabilities, high velocity exhaust, and integrated LED lighting.

Product features

- Powerful 70W ball bearing motor for superior reliability
- Infrared tube provides instant heat
- Built-in 80°C thermal cutout switch for added safety
- 3-year in-home warranty for peace of mind

Accessories

10361 AT9491 1000W RJ7S IR Heat Tube

14851 TIMER/RO 1-25min run-on timer

14853 DUCT/150/6M 150mm x 6m duct

13536 VENT/150/EXT/WH/SQ 150 mm vent

Product range

Code	Description
STMORITZ/WH SKU:16773	1000W infrared high velocity bathroom heater and exhaust with LED panels - Tri-CCT - White
STMORITZ/B SKU:14837	1000W infrared high velocity bathroom heater and exhaust with LED panels - Tri-CCT - Black

Product specification

Voltage	220-240V~50Hz
Light colour options	Tri-Colour 
Colour temperature	3000K, 4000K, 5000K
Lumen output	1585lm, 1700lm, 1585lm
Connection	Terminal block
Fan	Centrifugal fan
Exhaust	70W ball bearing motor
Noise level	45dB
Air Extraction	500m ³ /hr
Outlet	150mm
Light	20W LED panel
Heat	1000W R7S IR tube
Cutout	325x470mm
Min. ceiling depth	220mm
Warranty	3 years

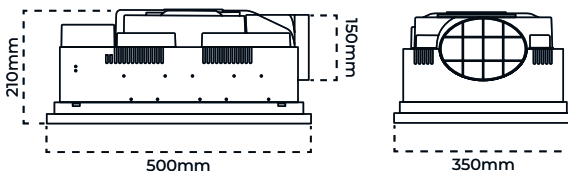



In Home
warranty



Infrared
heat tube



TRI-CCT
luminaire

ST MORITZ SMALL

The compact St Moritz Small 3-in-1 bathroom heater, exhaust fan, and LED light is a premium solution for small to medium-sized bathrooms and ensuites. It features a sleek and low-profile fascia, instant infrared heating capabilities, high velocity exhaust, and integrated LED lighting.

Product features

- Powerful 70W ball bearing motor for superior reliability
- Infrared tube provides instant heat
- Built-in 80°C thermal cutout switch for added safety
- 3-year in-home warranty for peace of mind

Accessories

10361 AT9491 1000W RJ7S IR Heat Tube

14851 TIMER/RO 1-25min run-on timer

14853 DUCT/150/6M 150mm x 6m duct

13536 VENT/150/EXT/WH/SQ 150 mm vent

Product range

Code	Description
STMORITZ/SML/WH SKU:14838	1000W infrared high velocity compact bathroom heater and exhaust with LED panel - White - Tri-CCT

Product specification

Voltage	220-240V~50Hz
Light colour options	Tri-Colour 
Colour temperature	3000K, 4000K, 5000K
Lumen output	700lm, 720lm, 710lm
Connection	Terminal block
Fan	Centrifugal fan
Exhaust	70W ball bearing motor
Noise level	45dB
Air Extraction	480m ³ /hr
Outlet	150mm
Light	10W LED panel
Heat	1000W R7S IR tube
Cutout	325x400mm
Min. ceiling depth	220mm
Warranty	3 years

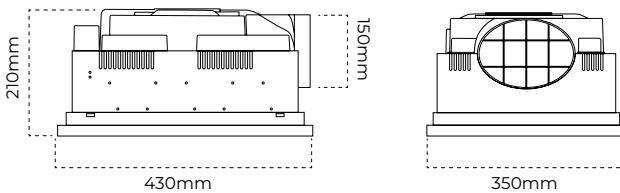



In Home
warranty



Infrared
heat tube



Low
profile

INFRAGLOW

Introducing the Infraglow, a stylish bathroom heater with infrared technology. This sleek unit provides rapid, direct heat, making it perfect for instant warmth. Straightforward to install, with a round template cutout included.

Product features

- 1000W infrared heat lamp provides instant, powerful heat
- Modern design enhances bathroom aesthetics
- Steel housing ensures durability and longevity
- Wall switch included
- Includes round template cutout for easy installation

Accessories

15178 AT9492/TUBE 1000W Heat Tube

Product range

Code	Description
INFRAGLOW/WH SKU: 14839	1000W radiant infrared bathroom heater - Round - White

Product specification

Voltage	220-240V~50Hz
Connection	Terminal block
IP Rating	IPX4
Heat	1000W circular IR tube
Cutout	Ø266mm
Min. ceiling depth	240mm
Warranty	3 years

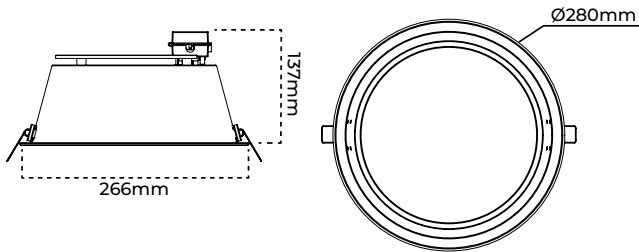



3YR
In Home
warranty



Instant
Infrared heat



Easy
install

HEATSPOT

Enjoy the warmth and comfort of the Heatspot, a single heat lamp for ensuites and small bathrooms. This compact unit provides powerful, instant body warmth, with a durable design and matte white finish.

Product features

- Infrared heat lamp provides instant warmth
- Perfect for ensuites and small bathrooms
- Quality steel housing ensures durability and longevity
- Easy to operate
- Matte white finish - Blends well with any bathroom décor

Accessories

18716 AT9709/ES/HEAT/275 lamp

Product range

Code	Description
HEATSPOT/WH SKU: 14840	275W single R125 heat spot - White

Product specification

Voltage	220-240V~50Hz
Connection	Terminal block
IP Rating	IPX0
Heat	275W R125 Heat Lamp
Cutout	Ø160mm
Min. ceiling depth	290mm
Warranty	3 years

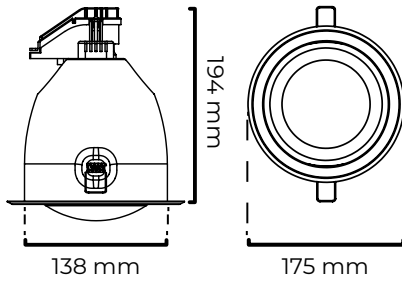



Accessories

Enhance and **customise** Atom Air bathroom products with our wide range of accessories, including lamps, infrared tubes, duct adapters, timers and fascias.

Our selection ensures bathroom heaters and exhaust fans perform at their best and match the homeowner's style preferences.

Timer	60
Other Accessories	62



TIMER

Run-on timers keep bathrooms free of steam and odours after use. This fully adjustable timer fits most exhaust fans and integrates easily behind existing switch plates.

Product features

- Allows you to set the exhaust fan to run for 1–25 minutes after leaving the room
- Fits within a wall-mounted switch plate or exhaust fan
- Easy mount design with moulded fastening hole
- Works with most exhaust fans and 3-in-1 units on the market
- Continues to eliminate steam and odours after you exit the bathroom

Product range

Code	Description	Suitable for
TIMER/RO SKU: 14851	1-25min run-on exhaust timer	All AC Exhaust Fans

NCC Building Code Update

The National Construction Code (NCC) 10.8.2 has been updated to improve ventilation standards in residential buildings. These changes ensure better air quality and moisture control in bathrooms and sanitary compartments. Here are the key points:

1. Minimum Flow Rates:

Bathrooms and sanitary compartments require a minimum flow rate of 25 L/s.

Kitchens or laundries require a minimum flow rate of 40 L/s.

2. Direct Discharge:

Exhaust systems in bathrooms and sanitary compartments must discharge air directly to the outside or via a duct.

3. Run-On Timer Requirement:

For exhaust systems not run continuously, serving bathrooms or sanitary compartments without natural ventilation, the system must:

- Be interlocked with the room's light switch.
- Include a run-on timer to continue operation for 10 minutes after the light is turned off.

4. Make-Up Air:

Rooms with exhaust systems must have make-up air openings to an adjacent room or in accordance with AS 1668.2, ensuring proper air balance.

Atom Air is at the forefront of addressing these changes. Our new **Azzure** exhaust fan with an integrated run-on timer ensures compliance with the updated NCC requirements, providing continuous ventilation to eliminate steam and odours. Additionally, our **Run-On Timer accessory** is compatible with most AC exhaust fans, allowing easy upgrades for existing systems.

By incorporating these innovative solutions, Atom Air continues to set the standard in ventilation technology, ensuring optimal air quality and moisture control in modern homes.

Infrared heat tubes

SKU	Code	Suitable for
10360	AT9490/TUBE 800W circular IR heat tube	ST MORITZ
15178	AT9492/TUBE 1000W circular heat tube	INFRAGLOW
10361	AT9491 1000W R7S IR heat tube	VENUS

Vents, ducting & duct adapters



13538 VENT/100/
EXT/WH/SQ



13535 VENT/125/
EXT/WH/SQ



13536 VENT/150/
EXT/WH/SQ



14852
DUCT/100/6M



14854
DUCT/125/6M



14853
DUCT/150/6M



12677
AT9492

SKU	Code	Suitable for
13538	VENT/100/EXT/WH/SQ 100mm square vent	100mm ducting
13535	VENT/125/EXT/WH/SQ 125mm square vent	125mm ducting
13536	VENT/150/EXT/WH/SQ 150mm square vent	150mm ducting
14852	DUCT/100/6M 100mm x 6m exhaust duct	100mm outlets
14854	DUCT/125/6M 125mm x 6m exhaust duct	125mm outlets
14853	DUCT/150/6M 150mm x 6m exhaust duct	150mm outlets
12677	AT9492 125mm duct adapter	ECLIPSE, ECLIPSE/LT

Timers

SKU	Code	Suitable for
14851	TIMER/RO 1-25min run-on exhaust timer	All AC Exhaust Fans

Fascias



16776 ECLIPSE/
TRIM/240/B/RD



16777 ECLIPSE/
TRIM/290/B/RD



16780 ECLIPSE/
TRIM/240/B/SQ



16781 ECLIPSE/
TRIM/290/B/SQ



16778 ECLIPSE/
TRIM/240/WH/SQ



16779 ECLIPSE/
TRIM/290/WH/SQ



16782 ECLIPSE/
TRIM/240/LT/WH/SQ

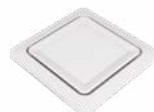

16783 ECLIPSE/
TRIM/290/LT/WH/SQ

SKU	Code	Suitable for
16776	ECLIPSE/TRIM/240/B/RD fascia	ECLIPSE/240, AZZURE
16777	ECLIPSE/TRIM/290/B/RD fascia	ECLIPSE/290
16780	ECLIPSE/TRIM/240/B/SQ fascia	ECLIPSE/240, AZZURE
16781	ECLIPSE/TRIM/290/B/SQ fascia	ECLIPSE/290
16778	ECLIPSE/TRIM/240/WH/SQ fascia	ECLIPSE/240, AZZURE
16779	ECLIPSE/TRIM/290/WH/SQ fascia	ECLIPSE/290
16782	ECLIPSE/TRIM/240/LT/WH/SQ fascia	ECLIPSE/LT/240, AZZURE
16783	ECLIPSE/TRIM/290/LT/WH/SQ fascia	ECLIPSE/LT/290

Lamps

SKU	Code	Suitable for
15372	AT9707/ES/TRI R63 8W LED lamp	THREDBO
15373	AT9708/ES/TRI R80 10W LED lamp	THREDBO
18716	AT9709/ES/HEAT/275 lamp	THREDBO, BULLER, HEATSPOT, ALTA, NIMBUS

Selection Guide

Exhaust Fans	Motor power (W)	Airflow specs (m ³ /hr)	Fan Type	Timer Included	Area suitability (m ²)*	Decibel rating (dB)	Light power (W)
ECLIPSE/240/WH/RD	30	270	Centrifugal		8	42	-
ECLIPSE/240/WH/SQ	30	270	Centrifugal		8	42	-
ECLIPSE/290/WH/RD	35	350	Centrifugal		10	45	-
ECLIPSE/290/WH/SQ	35	350	Centrifugal		10	45	-
ECLIPSE/240/LT/WH/RD	30	270	Centrifugal		8	42	12
ECLIPSE/290/LT/WH/RD	35	350	Centrifugal		10	45	18
AZZURE/240/WH/RD	30	270	Centrifugal	✓	8	42	-
GUST/240/WH/RD	35	330	Centrifugal		9	41	-
GUST/295/WH/RD	65	640	Centrifugal		18	45	-
GUST/295/LT/WH/RD	65	640	Centrifugal		18	45	18
AERO/240/WH/RD	30	370	Centrifugal		10	58	-
AERO/290/WH/RD	40	560	Centrifugal		16	53	-
VENTURA/240/WH/RD	20	420	Centrifugal		12	42	-
VENTURA/295/WH/RD	25	550	Centrifugal		16	37	-
VENTURA/240/LT/WH/RD	20	420	Centrifugal		12	42	12
VENTURA/295/LT/WH/RD	25	550	Centrifugal		16	37	12
PROTON/200/WH	25	500	Axial		14	34	-
PROTON/250/WH	32	750	Axial		21	36	-
AIRBOOST/150	55	450	Centrifugal		12	63	-
AIRBOOST/200	135	870	Centrifugal		24	68	-
WALLFLO/150	17	130	Axial		4	41	-

*Calculated based on 2.4m ceiling

†3000K, 4000K, 5000K

^Black fascias available separately

Lumens (lm)	CCT	CRI	LED lifetime (hr)	IP rating	Panel size (mm)	Colour	Cut out size (mm)	Min ceiling depth (mm)
-	-	-	-	IPX4	Ø270	Matte white ^a	Ø240	220
-	-	-	-	IPX4	270x270	Matte white ^a	Ø240	220
-	-	-	-	IPX4	Ø330	Matte white ^a	Ø290	220
-	-	-	-	IPX4	330x330	Matte white ^a	Ø290	220
900, 1000, 900	TRI-CCT ¹	>80	54,000	IPX4	Ø270	Matte white ^a	Ø240	220
1300, 1500, 1300	TRI-CCT ¹	>80	54,000	IPX4	Ø330	Matte white ^a	Ø290	220
-	-	-	-	IPX4	Ø270	Matte white	Ø240	220
-	-	-	-	IPX4	Ø275	Matte white	Ø240	200
-	-	-	-	IPX4	Ø320	Matte white	Ø295	240
1600, 1700, 1650	TRI-CCT ¹	>80	>60,000	IPX4	Ø320	Matte white	Ø295	240
-	-	-	-	IPX4	Ø272	Matte white	Ø240	185
-	-	-	-	IPX4	Ø315	Matte white	Ø290	220
-	-	-	-	IPX4	Ø275	Matte white	Ø240	250
-	-	-	-	IPX4	Ø320	Matte white	Ø295	250
1600, 1700, 1650	TRI-CCT ¹	>80	>60,000	IPX4	Ø275	Matte white	Ø240	250
1600, 1700, 1650	TRI-CCT ¹	>80	>60,000	IPX4	Ø320	Matte white	Ø295	250
-	-	-	-	IP20	Ø290	Gloss white	Ø240	215
-	-	-	-	IP20	Ø345	Gloss white	Ø295	260
-	-	-	-	IPX2	-	Matte white	-	-
-	-	-	-	IPX2	-	Matte white	-	-
-	-	-	-	IPX4	200x200	Matte white	Ø150	-

Selection Guide

Bathroom Heaters	Heater power (W)	Motor power (W)	Airflow specs (m³/hr)	Fan Type	Area suitability (m²)*	Decibel rating (dB)	Light power (W)
THREDBO/2LT/WH	2x275	45	280	Centrifugal	8	45	8
THREDBO/4LT/WH	4x275	45	280	Centrifugal	8	45	12
BULLER/2LT/WH	2x275	35	305	Centrifugal	9	42	10
BULLER/4LT/WH	4x275	35	305	Centrifugal	9	42	10
NIMBUS/2LT/WH	2x275	35	305	Centrifugal	9	42	10
NIMBUS/4LT/WH	4x275	35	305	Centrifugal	9	42	10
ALTA/2LT/WH	2x275	40	400	Centrifugal	11	47	10
SANTORINI/WH	2000	45	535	Centrifugal	15	52	20
SANTORINI/B	2000	45	535	Centrifugal	15	52	20
STMORITZ/WH	1000	70	500	Centrifugal	14	45	20
STMORITZ/B	1000	70	500	Centrifugal	14	45	20
STMORITZ/SML/WH	1000	70	480	Centrifugal	13	45	10
ZURICH/WH	2000	35	310	Centrifugal	9	38	20
INFRAGLOW/WH	1000	-	-	-	-	-	-
HEATSPOT/WH	275	-	-	-	-	-	-

*Calculated based on 2.4m ceiling

†3000K, 4000K, 5000K

Lumens (lm)	CCT	CRI	Light source	LED lifetime (hr)	IP rating	Panel size (mm)	Cut out size (mm)	Min ceiling depth (mm)
850	4000K	>80	R63 E27 lamp	15,000	IPX2	285x440	345x202	220
1250	4000K	>80	R80 E27 lamp	15,000	IPX2	360x400	295x295	220
880, 1000, 900	TRI-CCT ¹	>80	LED downlight	>60,000	IPX4	428x230	375x202	250
880, 1000, 900	TRI-CCT ¹	>80	LED downlight	>60,000	IPX4	360x360	320x320	250
880, 1000, 900	TRI-CCT ¹	>80	LED	>60,000	IPX4	419x244	375x202	250
880, 1000, 900	TRI-CCT ¹	>80	LED	>60,000	IPX4	370x370	320x320	250
810, 900, 880	TRI-CCT ¹	>80	LED panel	>54,000	IPX2	480x290	435x255	220
1300, 1450, 1350	TRI-CCT ¹	>80	LED panel	>36,000	IPX2	610x339	580x310	220
1300, 1450, 1350	TRI-CCT ¹	>80	LED panel	>36,000	IPX2	610x339	580x310	220
1585, 1695, 1585	TRI-CCT ¹	>80	LED panel	54,000	IPX2	500x350	470x325	220
1585, 1695, 1585	TRI-CCT ¹	>80	LED panel	54,000	IPX2	500x350	470x325	220
700, 720, 710	TRI-CCT ¹	>80	LED panel	54,000	IPX2	430x350	400x325	220
1200, 1300, 1200	TRI-CCT ¹	>80	LED panel	>54,000	IPX2	330x630	310x610	200
-	-	-	-	-	IPX4	Ø280	Ø266	240
-	-	-	-	-	IPX0	Ø175	Ø160	290

Frequently Asked Questions

Where is the best position to install the bathroom heater?

If the bathroom heater has an exhaust fan function, it is most important that it is positioned for effective clearing of steam from the room. Otherwise, simply ensure it is away from any walls or fittings that could be damaged from proximity to heat.

Where is the best position to install the exhaust fan?

The exhaust fan is best positioned as close as possible to the shower and away from windows or doors to create cross-ventilation. Size the fan to suit the room - refer to our handy size guide on page 64.

Can the heat lamps and exhaust fan be operated independently?

Yes, both functions can be operated independently via the gang switch - the heat lamps can run without the exhaust fan, the exhaust fan can run without the heat lamps, or both can be run simultaneously. Please refer to individual product models for specific operation.

Why is the exhaust fan not clearing all of the steam from the bathroom?

Poor performance from an exhaust fan can be due to it being undersized for the room, poor positioning of the unit, or a lack of fresh air being supplied to the room (such as an open window or door). Colder climates can also require higher extraction rates.

Can the switch plate be installed horizontally?

Yes, switch mechanisms are supplied separately so the installing electrician can fit the switch plate horizontally or vertically.

Is it possible to use a different switch plate to match the rest of the house?

Yes, the installing electrician can use a different switch plate as long as it is mains-rated.



Known for our **affordable quality** products, Atom's diverse range offers solutions for every application, inside and out – from downlights, globes and strip lighting, to exterior spots, oysters and more.

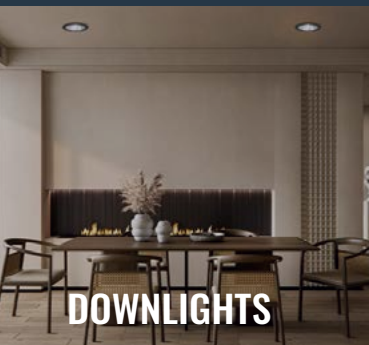

DOWNLIGHTS

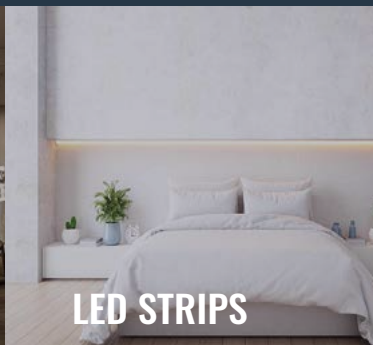

LED STRIPS

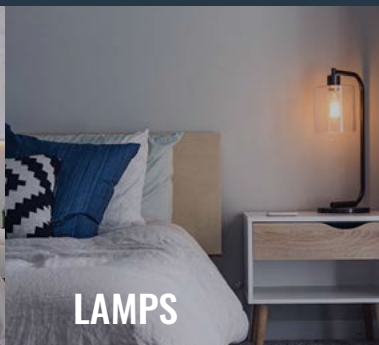

LAMPS

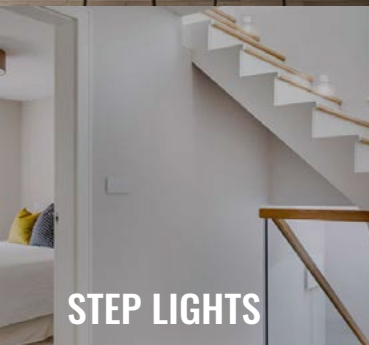

STEP LIGHTS



EXTERIOR LIGHTING



OYSTERS



EXHAUST FANS



BATHROOM HEATERS



CEILING FANS

atom'air





atom'air

Due to changes in industry standards and Atom's policy of continual product development, product specifications are subject to change without notice. Images are for illustrative purpose only. E&OE. For more information, please visit our website.

evolt

© Evolt May, 2026

Unit 2C/40 Barracks Rd,
Wacol QLD 4076
sales@evolt.com.au
1300 438 658
evolt.com.au